

GAGGIA

MILANO

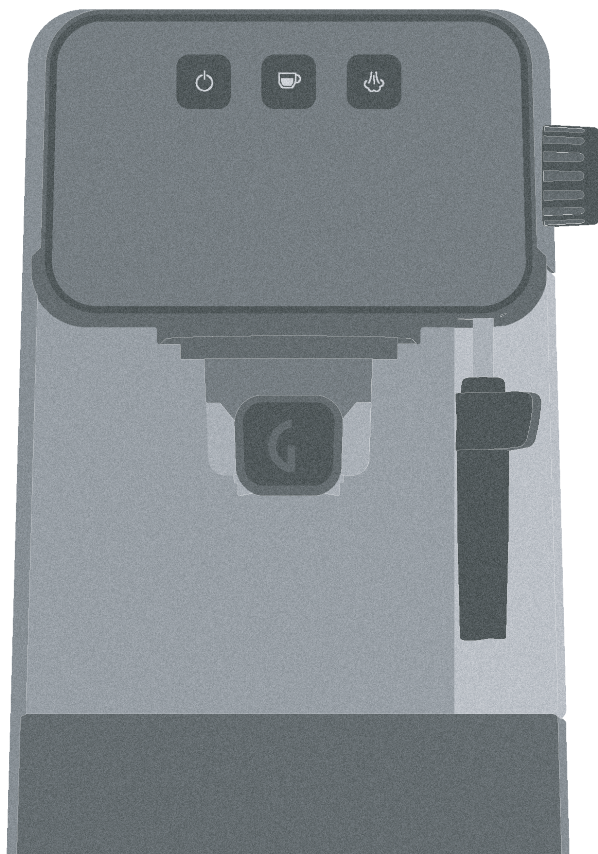

GAGGIA ESPRESSO



EG2109



STYLE



DELUXE



EVOLUTION

ESPRESSO EVOLUTION

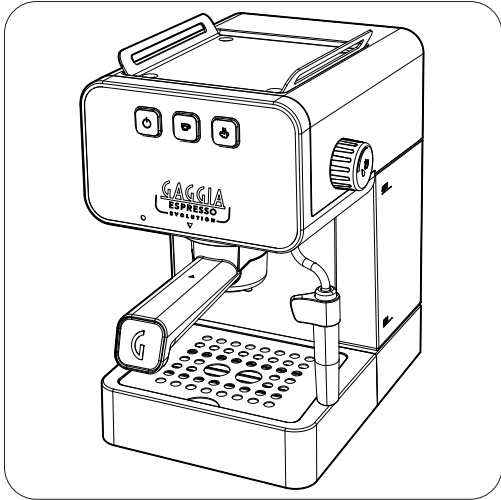

ESPRESSO DELUXE

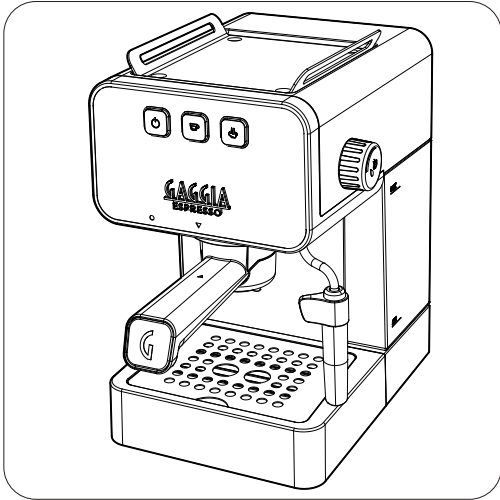

ESPRESSO STYLE

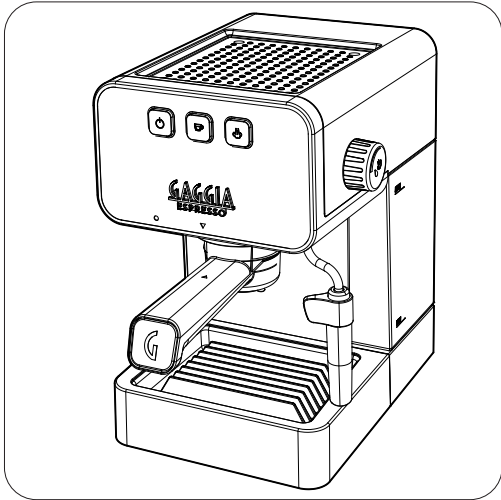

EG 2109

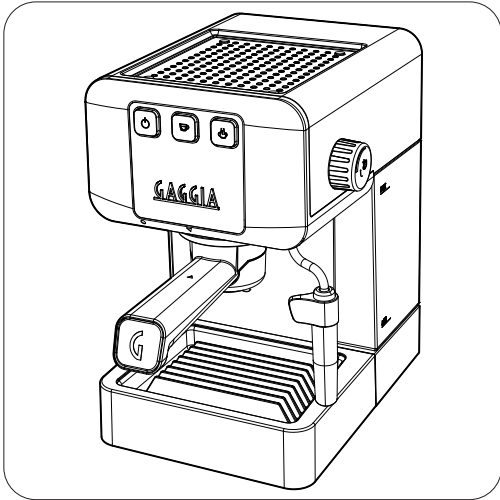

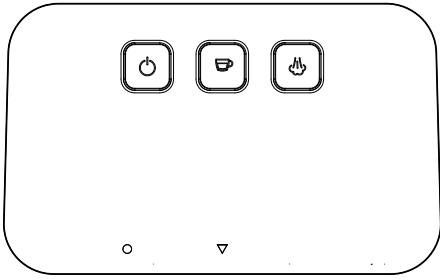

Evolution
Deluxe

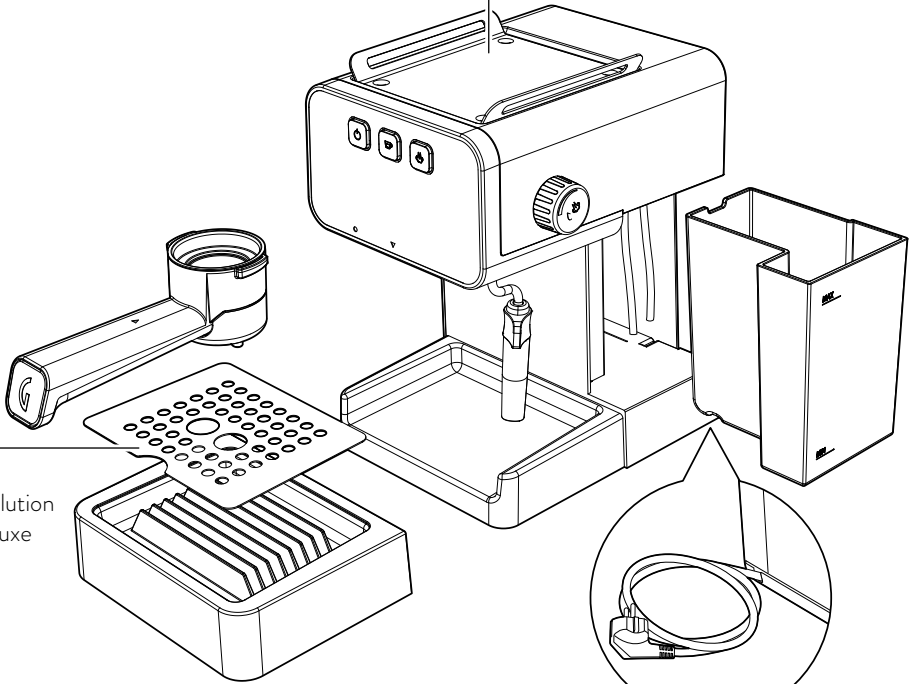

Evolution
Deluxe

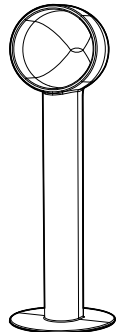
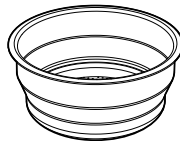
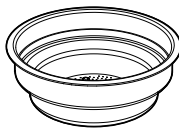
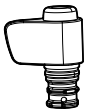

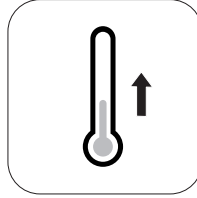
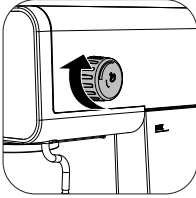
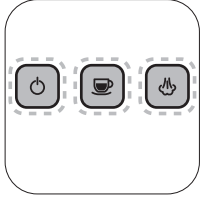
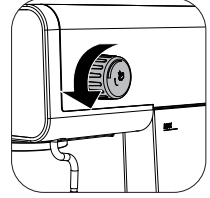
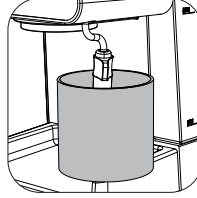
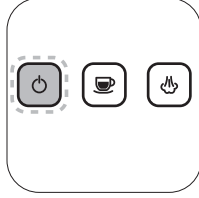
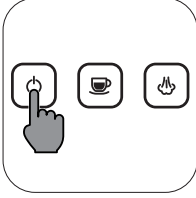
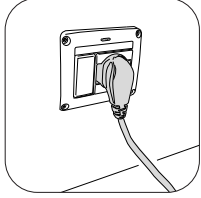
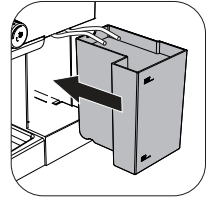
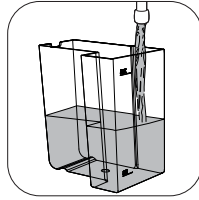
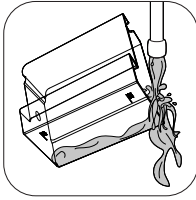
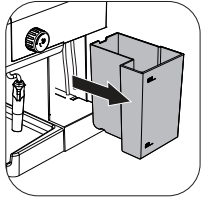

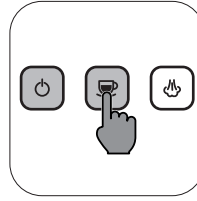
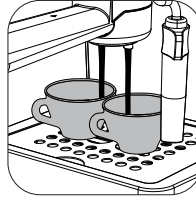
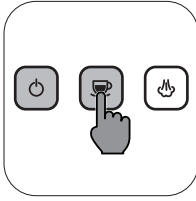
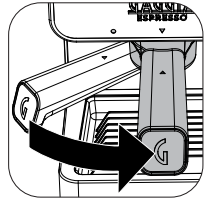
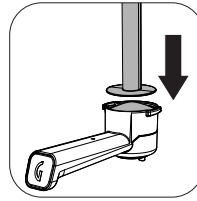
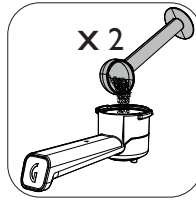
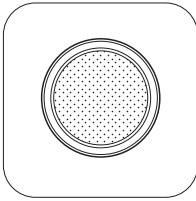
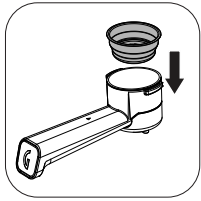
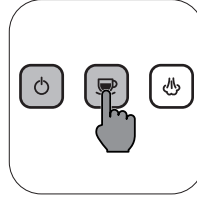
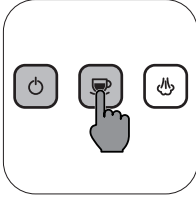
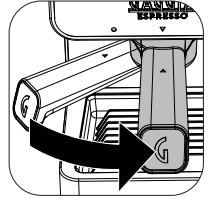
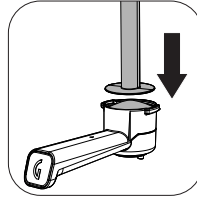
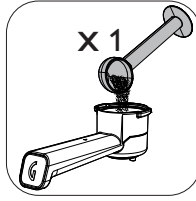
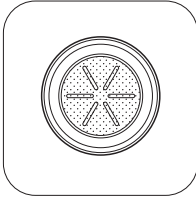
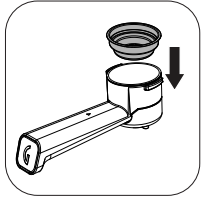

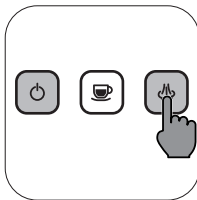
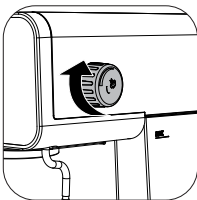
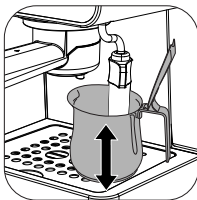
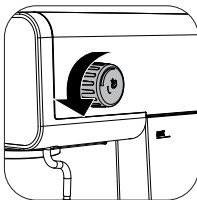
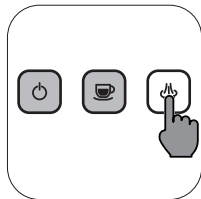
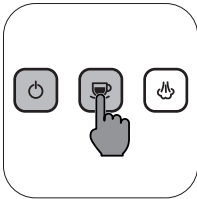
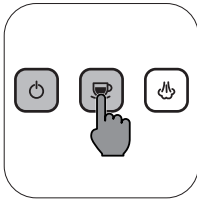
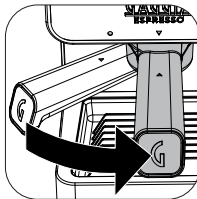
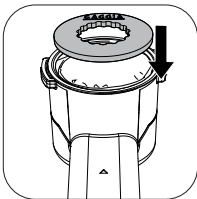
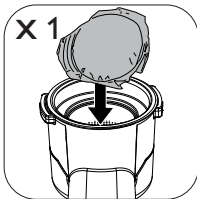
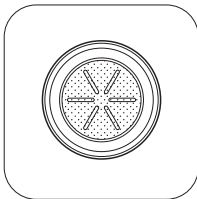
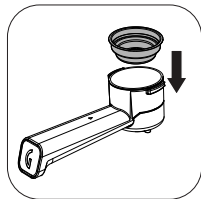

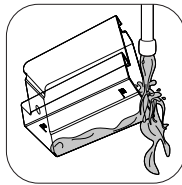
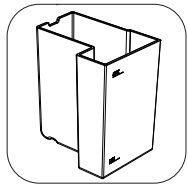
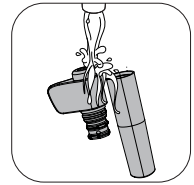
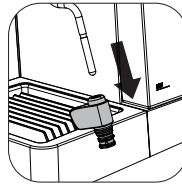
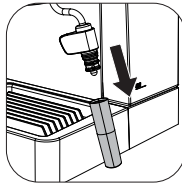
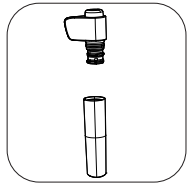
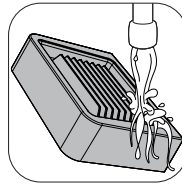
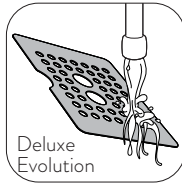
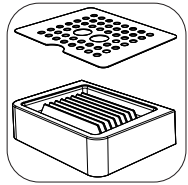
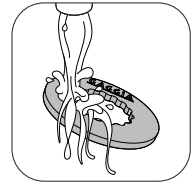
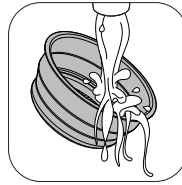
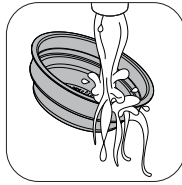
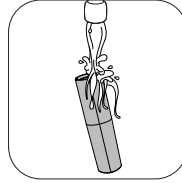
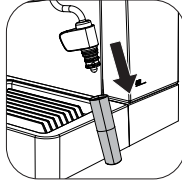
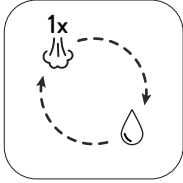
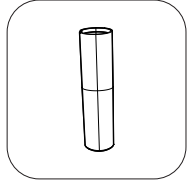
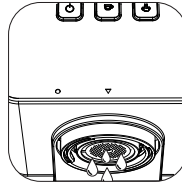
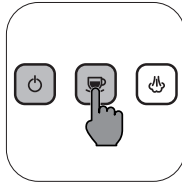

GAGGIA S.p.A. reserves the right to make any necessary modification.

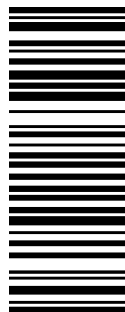

642001017147

COD.

- Rev.00 - 18/07/24

GAGGIA S.p.A.

Sede Amministrativa/Administrative Office

Via Torretta, 240

40041 Gaggio Montano - Bologna - Italia

+39 0534 771111

www.gaggia.com

GAGGIA
MILANO